

### PRODUCT DESCRIPTION

The FPSI 1010 uses the latest miniaturisation techniques to produce a very compact voltage level indicator. The module compares an input voltage to a defined voltage window. The colour of the display shows whether the input voltage is below, within or above this window. The indicator provides a red-green-red bright LED indication over a 0 to 2.5V or 0 to 5V input voltage range. The user can easily set the colour switching thresholds (an optional programmer is available - FPSI 1010 PROG). Hysteresis is included to avoid chattering at the colour switching thresholds. The module incorporates three outputs, one for each colour level, allowing the user to drive external alarms or to control the process being monitored. A low power mode is also available, whereby the module indicates the voltage level by flashing the relevant colour, instead of indicating solid colours. Connection to the 10x10mm module is via 8-way DIL pins. This unique product is designed to be a drop-in component in most medium and high volume applications, ranging from personal instrumentation and integral sensor indicators to control panel status displays. This module is supplied with a plastic mounting bezel, requiring a 12.6 x 12.6mm (0.5x0.5") cut-out.

### FEATURES

- Bright Red and Green Indication
- 0 to 2.5Vd.c. and 0 to 5.0Vd.c. Measurement Ranges
- 2 User Programmable Thresholds
- 5V d.c. Supply Voltage
- Low Power Mode
- Easy to Set up and Use
- 8-Pin DIL Package
- Module can be customised on request

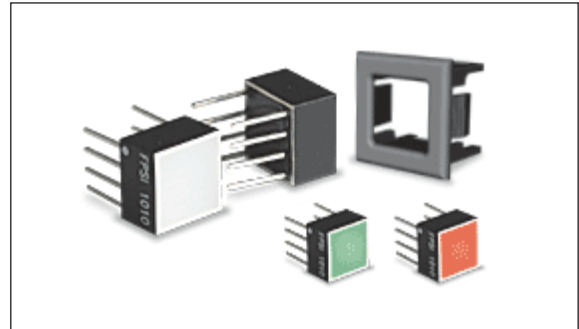

### TYPICAL APPLICATIONS

- Go - No Go Indication
- Level Monitoring
- Alarm Indication
- Process Control
- Automated Test Equipment

### ORDERING INFORMATION

	Stock Number
Standard Indicator	FPSI 1010
Programmer	FPSI 1010 PROG

### ELECTRICAL SPECIFICATIONS

Specification	Min.	Typ.	Max.	Unit
Supply voltage (V+ to 0V)	4.75	5	5.5*	V d.c.
Supply current	Display not flashing	15		mA
	Display flashing (average current)		2.5	mA
Input Voltage (Vin to 0V)	Vref not connected	0	2.5	Vd.c.
	Vref connected to +5.0V	0	5.0	Vd.c.
Internal resolution	Vref not connected	2.5		mV
	Vref connected to +5.0V		5.0	mV
Accuracy (overall error)		0.4		%
Temperature stability		100		ppm/°C
Hysteresis		2		%
Sample rate		4		Samples/sec
Operating temperature range	-30		+70	°C
Input impedance		1		kOhm
Output High Voltage (pins 5, 6, 7)	V+ - 0.7		V+	V d.c.
Output High Current (pins 5, 6, 7)			1	mA
Output Low Voltage (pins 5, 6, 7)	0		0.6	V d.c.
Output Low Current (pins 5, 6, 7)			1	mA

\* Operation of the indicator beyond the maximum supply voltage rating may cause permanent damage to the indicator.

### SAFETY

To comply with the Low Voltage Directive (LVD 93/68/EEC), input voltages to the module's pins must not exceed 60Vdc. The user must ensure that the incorporation of the panel meter into the user's equipment conforms to the relevant sections of BS EN 61010 (Safety Requirements for Electrical Equipment for Measuring, Control and Laboratory Use).

LASCAR ELECTRONICS LTD.  
MODULE HOUSE  
WHITEPARISH  
WILTSHIRE SP5 2SJ  
UK  
TEL: +44 (1794) 884567  
FAX: +44 (1794) 884616  
E-mail: sales@lascar.co.uk

LASCAR ELECTRONICS INC.  
3750 West 26th Street  
Erie  
PA 16506  
USA  
TEL: +1 (814) 835 0621  
FAX: +1 (814) 838 8141  
E-mail: us-sales@lascarelectronics.com

LASCAR ELECTRONICS (HK) LIMITED  
FLAT C, 5/FL., LUCKY FTY. BLDG.  
63-65 HUNG TO ROAD  
KWUN TONG KOWLOON  
HONG KONG  
TEL: +852 2797 3219  
FAX: +852 2343 6187  
E-mail: b4lascar@samsongroup.com.hk

Specifications liable to change without prior warning

FPSI 1010

Issue 3

October/2003

M.C.

Applies to FPSI 1010/1



### DIMENSIONS

All dimensions in mm (inches)

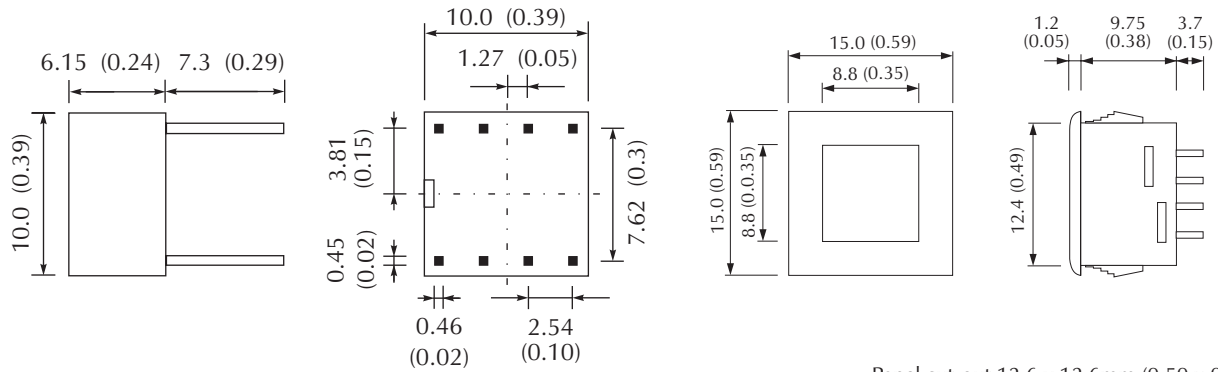

### FUNCTIONAL BLOCK DIAGRAM

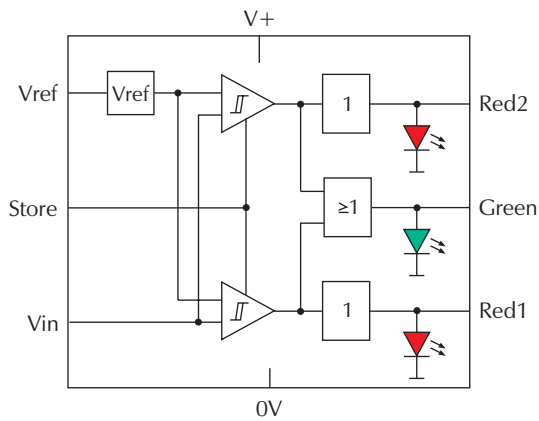

### PIN CONFIGURATION

(bottom view)

White dot on side of module identifies Pin 1

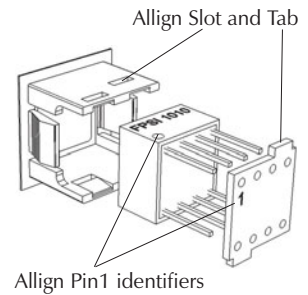
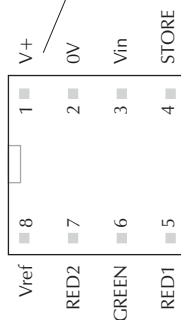

### HYSTERESIS

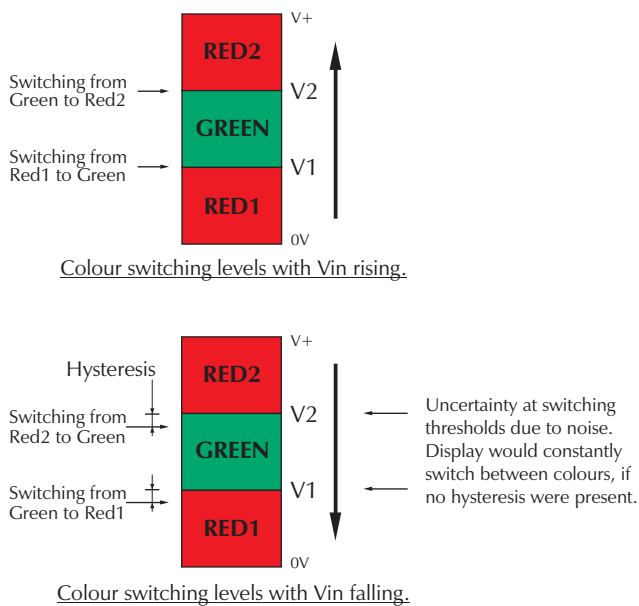

Hysteresis is built into the FPSI 1010. It cannot be switched off.

### FLASHING MODE TIMING

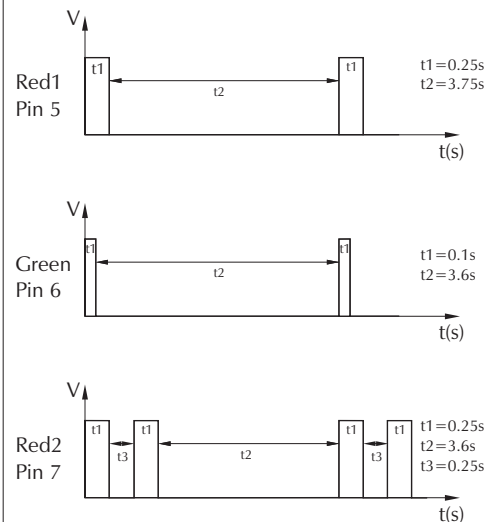

### PIN FUNCTIONS

1. V+ Positive power supply to the level indicator.
2. 0V Negative power supply to the level indicator.
3. Vin Measuring input with reference to 0V.
4. STORE Connecting to V-: See "Configuring The Level Indicator" for further details.
5. RED1 This pin goes High when the voltage on Pin 3 is lower than the switching threshold V1.
6. GREEN This pin goes High when the voltage on Pin 3 is between the switching thresholds V1 and V2.
7. RED2 This pin goes High when the voltage on Pin 3 is higher than the switching threshold V2.
8. Vref This pin reflects the reference voltage for the module's measurement circuit.  
Connect Vref to +5.0V to change the indicator's measurement range from 0 to 2.5V to 0 to 5.0V.

### SCALING

The FPSI 1010 features a voltage measurement range of 2.5Vd.c. on Vin (Vref not connected). Two resistors Ra and Rb may be used to alter the measurement range of the indicator. Use the following formulae to calculate values of Ra and Rb for voltage and current measurement.

Vref connected to 5.0V (S closed)	Vref not connected (S open)
<u>Voltage Scaling</u> $R_a = R_b \frac{(V_{in} - 1)}{2.5}$ $R_b = 1k\Omega$	<u>Voltage Scaling</u> $R_a = R_b \frac{(V_{in} - 1)}{5.0}$ $R_b = 1k\Omega$
<u>Current Scaling</u> $R_a = 0\Omega$ $R_b = \frac{2.5V}{I_{in}(\text{full scale})}$	<u>Current Scaling</u> $R_a = 0\Omega$ $R_b = \frac{5.0V}{I_{in}(\text{full scale})}$

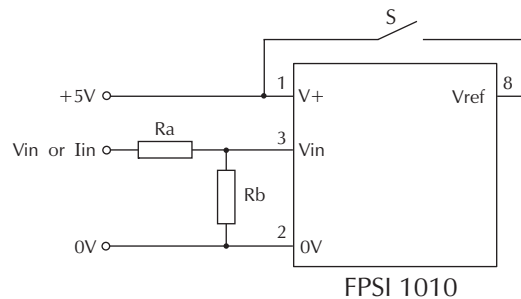

### CONFIGURING THE LEVEL INDICATOR

The indicator is factory configured with colour switching thresholds, as follows:

V1 = 1.67V and V2 = 3.33V (when Vref is connected to +5.0V)

V1 = 0.83V and V2 = 1.67V (when Vref is not connected)

To change this setting, proceed as follows.

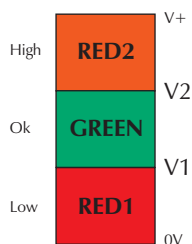

#### Step 1

- Connect the V+ and 0V pins of the FPSI 1010 to a 5Vd.c. supply.

#### Step 2

- Apply the first desired voltage (V1) to Vin, then press S<sub>STORE</sub>.  
- Module flashes Green to indicate that the V1 level has been stored.

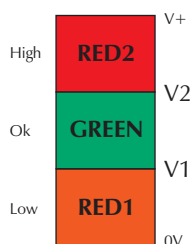

#### Step 3

- Apply the second desired voltage (V2) to Vin, then press S<sub>STORE</sub>.  
- Module flashes Red to indicate that the V2 level has been stored.

#### Step 4

- To enter solid LED mode, make sure Vin does not change, then press S<sub>STORE</sub>.  
- To enter flashing LED mode, change Vin by 100mV or more, then press S<sub>STORE</sub>.  
- Module flashes Red or Green to indicate that the LED mode has been stored.

#### Step 5

- Disconnect the module. The module is now ready for use.

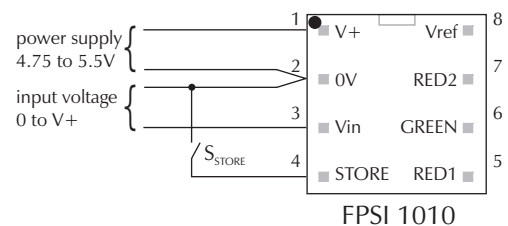

To facilitate programming of the colour switching thresholds, an optional programmer is available - FPSI 1010 PROG.

### APPLICATIONS (Module pin-out shown top view)

Taking any input beyond the power supply rails will damage the FPSI 1010.

**Note:** If the FPSI 1010 module is configured for flashing mode, then the relevant RED1, GREEN and RED2 outputs will also pulse High and Low (see Flashing Mode Timing section of this datasheet).

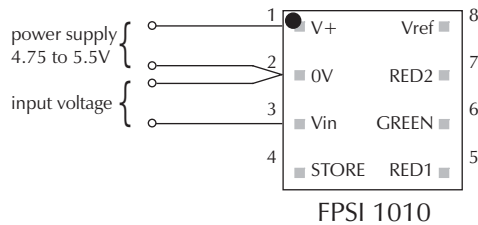

#### Basic operation

- The indicator is - red when the Vin voltage is between 0V and V1
- green when the Vin voltage is between V1 and V2
- red when the Vin voltage is between V2 and V+

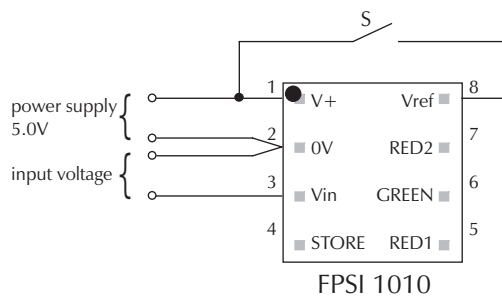

#### Switching between measurement ranges

- When S is open, the measurement range is 2.5Vd.c.
- When S is closed, the measurement range is 5Vd.c.

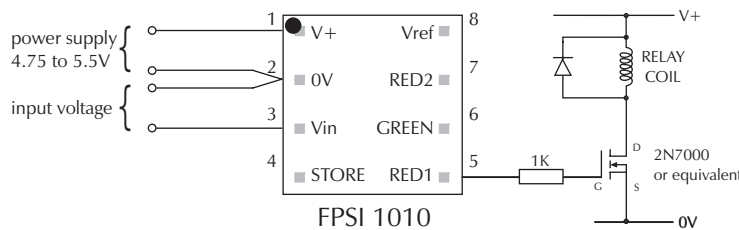

#### Driving a Relay

One of the 3 outputs is shown driving a relay. Pins 5, 6 and 7 must not be allowed to source more than 1mA.

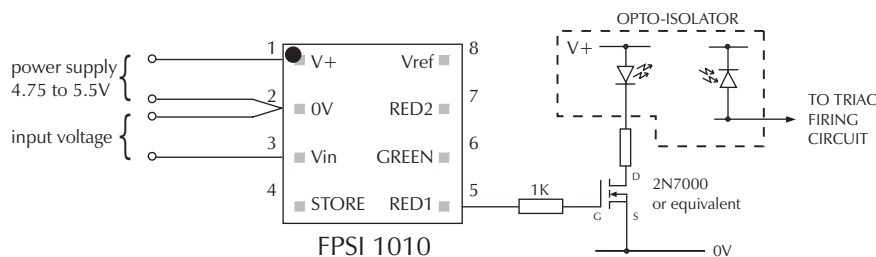

#### Driving a Triac

One of the 3 outputs is shown driving a triac. Pins 5, 6 and 7 must not be allowed to source more than 1mA.



Consult the MOSFET datasheet for maximum drain current.

Bottom View of 2N7000

